

Welding — Fusion-welded joints in steel, nickel, titanium and their alloys (beam welding excluded) — Quality levels for imperfections

The European Standard EN ISO 5817:2007 has the status of a
British Standard

ICS 25.160.40

National foreword

This British Standard is the UK implementation of EN ISO 5817:2007. It supersedes BS EN ISO 5817:2003 which is withdrawn.

The UK participation in its preparation was entrusted to Technical Committee WEE/-/1, Briefing committee for welding.

A list of organizations represented on this committee can be obtained on request to its secretary.

This publication does not purport to include all the necessary provisions of a contract. Users are responsible for its correct application.

Compliance with a British Standard cannot confer immunity from legal obligations.

This British Standard was published under the authority of the Standards Policy and Strategy Committee on 31 August 2007

© BSI 2007

ISBN 978 0 580 56192 4

Amendments issued since publication

Amd. No.	Date	Comments

English Version

Welding - Fusion-welded joints in steel, nickel, titanium and their alloys (beam welding excluded) - Quality levels for imperfections (ISO 5817:2003, corrected version:2005, including Technical Corrigendum 1:2006)

Soudage - Assemblages en acier, nickel, titane et leurs alliages soudés par fusion (soudage par faisceau exclu) - Niveaux de qualité par rapport aux défauts (ISO 5817:2003, version corrigée:2005, Corrigendum Technique 1:2006 inclus)

Schweißen - Schmelzschweißverbindungen an Stahl, Nickel, Titan und deren Legierungen (ohne Strahlschweißen) - Bewertungsgruppen von Unregelmäßigkeiten (ISO 5817:2003, korrigierte Fassung:2005, einschließlich Technisches Corrigendum 1:2006)

This European Standard was approved by CEN on 18 July 2007.

CEN members are bound to comply with the CEN/CENELEC Internal Regulations which stipulate the conditions for giving this European Standard the status of a national standard without any alteration. Up-to-date lists and bibliographical references concerning such national standards may be obtained on application to the CEN Management Centre or to any CEN member.

This European Standard exists in three official versions (English, French, German). A version in any other language made by translation under the responsibility of a CEN member into its own language and notified to the CEN Management Centre has the same status as the official versions.

CEN members are the national standards bodies of Austria, Belgium, Bulgaria, Cyprus, Czech Republic, Denmark, Estonia, Finland, France, Germany, Greece, Hungary, Iceland, Ireland, Italy, Latvia, Lithuania, Luxembourg, Malta, Netherlands, Norway, Poland, Portugal, Romania, Slovakia, Slovenia, Spain, Sweden, Switzerland and United Kingdom.



EUROPEAN COMMITTEE FOR STANDARDIZATION
COMITÉ EUROPÉEN DE NORMALISATION
EUROPÄISCHES KOMITEE FÜR NORMUNG

Management Centre: rue de Stassart, 36 B-1050 Brussels

Foreword

The text of ISO 5817:2003, corrected version:2005, including Technical Corrigendum 1:2006 has been prepared by Technical Committee ISO/TC 44 "Welding and allied processes" of the International Organization for Standardization (ISO) and has been taken over as EN ISO 5817:2007 by Technical Committee CEN/TC 121 "Welding", the secretariat of which is held by DIN.

This European Standard shall be given the status of a national standard, either by publication of an identical text or by endorsement, at the latest by February 2008, and conflicting national standards shall be withdrawn at the latest by February 2008.

This document supersedes EN ISO 5817:2003.

According to the CEN/CENELEC Internal Regulations, the national standards organizations of the following countries are bound to implement this European Standard: Austria, Belgium, Bulgaria, Cyprus, Czech Republic, Denmark, Estonia, Finland, France, Germany, Greece, Hungary, Iceland, Ireland, Italy, Latvia, Lithuania, Luxembourg, Malta, Netherlands, Norway, Poland, Portugal, Romania, Slovakia, Slovenia, Spain, Sweden, Switzerland and United Kingdom.

Endorsement notice

The text of ISO 5817:2003, corrected version:2005, including Technical Corrigendum 1:2006 has been approved by CEN as EN ISO 5817:2007 without any modifications.

INTERNATIONAL STANDARD

ISO 5817

Second edition
2003-10-01

Corrected version
2005-11-01

Welding — Fusion-welded joints in steel, nickel, titanium and their alloys (beam welding excluded) — Quality levels for imperfections

*Soudage — Assemblages en acier, nickel, titane et leurs alliages
soudés par fusion (soudage par faisceau exclu) — Niveaux de qualité
par rapport aux défauts*



Reference number
ISO 5817:2003(E)

Contents

Page

Foreword	iv
Introduction	v
1 Scope	1
2 Normative references	2
3 Terms and definitions	2
4 Symbols	3
5 Assessment of imperfections	4
Annex A (informative) Examples of determination of percentage (%) porosity	22
Annex B (informative) Additional information and guidelines for use of this International Standard	24
Bibliography	25

Foreword

ISO (the International Organization for Standardization) is a worldwide federation of national standards bodies (ISO member bodies). The work of preparing International Standards is normally carried out through ISO technical committees. Each member body interested in a subject for which a technical committee has been established has the right to be represented on that committee. International organizations, governmental and non-governmental, in liaison with ISO, also take part in the work. ISO collaborates closely with the International Electrotechnical Commission (IEC) on all matters of electrotechnical standardization.

International Standards are drafted in accordance with the rules given in the ISO/IEC Directives, Part 2.

The main task of technical committees is to prepare International Standards. Draft International Standards adopted by the technical committees are circulated to the member bodies for voting. Publication as an International Standard requires approval by at least 75 % of the member bodies casting a vote.

Attention is drawn to the possibility that some of the elements of this document may be the subject of patent rights. ISO shall not be held responsible for identifying any or all such patent rights.

ISO 5817 was prepared by Technical Committee ISO/TC 44, *Welding and allied processes*, Subcommittee SC 10, *Unification of requirements in the field of metal welding*.

This second edition cancels and replaces the first edition (ISO 5817:1992), which has been technically revised.

Extensive editorial and technical changes have been made throughout this corrected version. For example, the first paragraph of the Scope has been modified.

Introduction

This International Standard should be used as a reference in the drafting of application codes and/or other application standards. It contains a simplified selection of fusion weld imperfections based on the designations given in ISO 6520-1.

Some of the imperfections described in ISO 6520-1 have been used directly and some have been grouped together. The basic numerical referencing system from ISO 6520-1 has been used.

The purpose of this International Standard is to define dimensions of typical imperfections which might be expected in normal fabrication. It may be used within a quality system for the production of welded joints. It provides three sets of dimensional values from which a selection can be made for a particular application. The quality level necessary in each case should be defined by the application standard or the responsible designer in conjunction with the manufacturer, user and/or other parties concerned. The quality level shall be prescribed before the start of production, preferably at the enquiry or order stage. For special purposes, additional details may be prescribed.

The quality levels given in this International Standard provide basic reference data and are not specifically related to any particular application. They refer to types of welded joint in fabrication and not to the complete product or component itself. It is possible, therefore, that different quality levels are applied to individual welded joints in the same product or component.

It would normally be expected that for a particular welded joint the dimensional limits for imperfections could all be covered by specifying one quality level. In some cases, it may be necessary to specify different quality levels for different imperfections in the same welded joint.

The choice of quality level for any application should take account of design considerations, subsequent processing (e.g. surfacing), mode of stressing (e.g. static, dynamic), service conditions (e.g. temperature, environment) and consequences of failure. Economic factors are also important and should include not only the cost of welding but also of inspection, test and repair.

Although this International Standard includes types of imperfection relevant to the fusion welding processes listed in Clause 1, only those which are applicable to the process and application in question need to be considered.

Imperfections are quoted in terms of their actual dimensions, and their detection and evaluation may require the use of one or more methods of non-destructive testing. The detection and sizing of imperfections is dependent on the inspection methods and the extent of testing specified in the application standard or contract.

This International Standard does not address the methods used for the detection of imperfections. However, ISO 17635 contains a correlation between the quality level and acceptance level for different NDT methods.

This International Standard is directly applicable to visual testing of welds and does not include details of recommended methods of detection or sizing by non-destructive means. It should be considered that there are difficulties in using these limits to establish appropriate criteria applicable to non-destructive testing methods such as ultrasonic, radiographic, eddy current, penetrate, magnetic particle testing and may need to be supplemented by requirements for inspection, examining and testing.

The values given for imperfections are for welds produced using normal welding practice. Requirements for smaller (more stringent) values as stated in quality level B may include additional manufacturing processes, e.g. grinding, TIG dressing.

Requests for official interpretations of any aspect of this International Standard should be directed to the Secretariat of ISO/TC 44/SC 10 via your national standards body. For a complete listing consult www.iso.org.

Welding — Fusion-welded joints in steel, nickel, titanium and their alloys (beam welding excluded) — Quality levels for imperfections

1 Scope

This International Standard provides quality levels of imperfections in fusion-welded joints (except for beam welding) in all types of steel, nickel, titanium and their alloys. It applies to material thickness above 0,5 mm. It covers fully penetrated butt welds and all fillet welds. The principles of this International Standard may also be applied to partial-penetration butt welds.

Quality levels for beam welded joints in steel are presented in ISO 13919-1.

Three quality levels are given in order to permit application to a wide range of welded fabrication. They are designated by symbols B, C and D. Quality level B corresponds to the highest requirement on the finished weld. The quality levels refer to production quality and not to the fitness-for-purpose (see 3.2) of the product manufactured.

This International Standard applies to:

- unalloyed and alloy steels;
- nickel and nickel alloys;
- titanium and titanium alloys;
- manual, mechanized and automatic welding;
- all welding positions;
- all types of welds, e.g. butt welds, fillet welds and branch connections;
- the following welding processes and their defined sub-processes in accordance with ISO 4063:
 - 11 metal-arc welding without gas protection;
 - 12 submerged-arc welding;
 - 13 gas-shielded metal-arc welding;
 - 14 gas-shielded welding with non-consumable electrodes;
 - 15 plasma arc welding;
 - 31 oxy-fuel gas welding (for steel only).

Metallurgical aspects, e.g. grain size, hardness, are not covered by this International Standard.

2 Normative references

The following referenced documents are indispensable for the application of this document. For dated references, only the edition cited applies. For undated references, the latest edition of the referenced document (including any amendments) applies.

ISO 2553, *Welded, brazed and soldered joints — Symbolic representation on drawings*

ISO 4063, *Welding and allied processes — Nomenclature of processes and reference numbers*

ISO 6520-1:1998, *Welding and allied processes — Classification of geometric imperfections in metallic materials — Part 1: Fusion welding*

ISO 13919-1, *Welding — Electron and laser-beam welded joints — Guidance on quality levels for imperfections — Part 1: Steel*

3 Terms and definitions

For the purposes of this document, the following terms and definitions apply.

3.1 quality level

description of the quality of a weld on the basis of type, size and amount of selected imperfections

3.2 fitness-for-purpose

ability of a product, process or service to serve a defined purpose under specific conditions

3.3 short imperfections

in cases when the weld is 100 mm long or longer, imperfections are considered to be short imperfections if, in the 100 mm which contains the greatest number of imperfections, their total length is less than 25 mm

in cases when the weld is less than 100 mm long, imperfections are considered to be short imperfections if their total length is less than 25 % of the length of the weld

3.4 systematic imperfection

imperfections that are repeatedly distributed in the weld over the weld length to be examined, the size of a single imperfection being within the specified limits

3.5 projected area

area where imperfections distributed along the volume of the weld under consideration are imaged two-dimensionally

NOTE In contrast to the cross-sectional area, the occurrence of imperfections is dependent on the weld thickness when exposed radiographically (see Figure 1).

3.6 cross-sectional area

area to be considered after fracture or sectioning

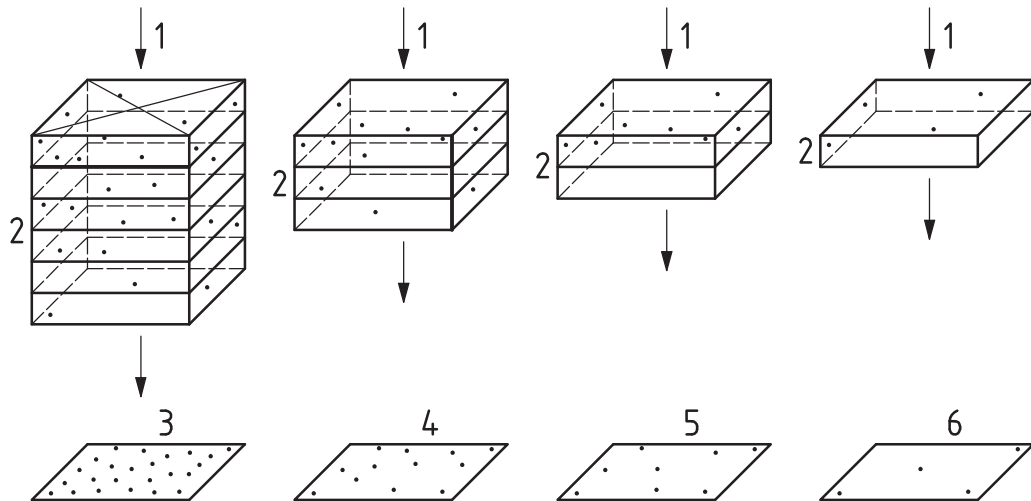
**Key**

1	X-ray detection	3	6-fold thickness	5	2-fold thickness
2	4 pores per volume unit	4	3-fold thickness	6	1-fold thickness

Figure 1 — Radiographic films of specimens with identical occurrence of pores per volume unit

4 Symbols

The following symbols are used in Table 1.

a	nominal throat thickness of the fillet weld (see also ISO 2553)
A	area surrounding the gas pores
b	width of weld reinforcement
d	diameter of gas pore
d_A	diameter of area surrounding the gas pores
h	height or width of imperfection
l	length of imperfection in longitudinal direction of the weld
l_p	length of projected or cross-sectional area
s	nominal butt weld thickness (see also ISO 2553)
t	wall or plate thickness (nominal size)
w_p	width of the weld or width or height of the cross-sectional area
z	leg length of a fillet weld (see also ISO 2553)
α	angle of weld toe
β	angle of angular misalignment

5 Assessment of imperfections

Limits for imperfections are given in Table 1.

If, for the detection of imperfections, micro-examination is used, only those imperfections shall be considered which can be detected with a maximum of tenfold magnification. Excluded from this are micro lack of fusion (see Table 1, 1.5) and microcracks (see Table 1, 2.2).

Systematic imperfections are only permitted in quality level D, provided other requirements of Table 1 are fulfilled.

A welded joint should usually be assessed separately for each individual type of imperfection (see Table 1, 1.1 to 3.2).

Different types of imperfection occurring at any cross-section of the joint need special consideration (see multiple imperfections in Table 1, 4.1).

The limits for multiple imperfections (see Table 1) are only applicable for cases where the requirements for a single imperfection are not exceeded.

Any two adjacent imperfections separated by a distance smaller than the major dimension of the smaller imperfection shall be considered as a single imperfection.

Table 1 — Limits for imperfections

No.	Reference to ISO 6520-1:1998	Imperfection designation	Remarks	t mm	Limits for imperfections for quality levels		
					D	C	B
1 Surface imperfections							
1.1	100	Crack	—	≥ 0,5	Not permitted	Not permitted	Not permitted
1.2	104	Crater crack	—	≥ 0,5	Not permitted	Not permitted	Not permitted
1.3	2017	Surface pore	Maximum dimension of a single pore for	0,5 to 3	$d \leq 0,3 s$ $d \leq 0,3 a$	Not permitted	Not permitted
			— butt welds				
1.4	2025	End crater pipe	Maximum dimension of a single pore for	> 3	$d \leq 0,3 s$, but max. 3 mm $d \leq 0,3 a$, but max. 3 mm	Not permitted	Not permitted
			— butt welds — fillet welds				
1.5	401	Lack of fusion (incomplete fusion)	Only detectable by micro examination	≥ 0,5	Not permitted	Not permitted	Not permitted
1.6	4021	Incomplete root penetration	Only for single side butt welds	≥ 0,5	Short imperfections: $h \leq 0,2 t$, but max. 2 mm	Not permitted	Not permitted

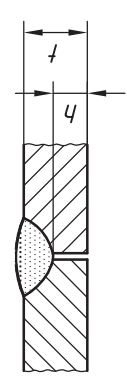
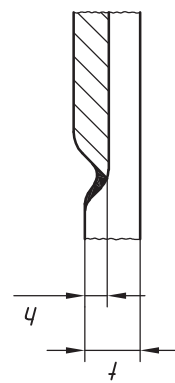

Table 1 (continued)

No.	Reference to ISO 6520-1:1998	Imperfection designation	Remarks	t mm	Limits for imperfections for quality levels		
					D	C	B
1.7	5011 5012	Continuous undercut Intermittent undercut	Smooth transition is required. This is not regarded as a systematic imperfection. 	0,5 to 3	Short imperfections: $h \leq 0,2 t$	Short imperfections: $h \leq 0,1 t$	Not permitted
				> 3	$h \leq 0,2 t$, but max. 1 mm	$h \leq 0,1 t$, but max. 0,5 mm	$h \leq 0,05 t$, but max. 0,5 mm
1.8	5013	Shrinkage groove	Smooth transition is required. 	0,5 to 3	$h \leq 0,2 \text{ mm} + 0,1 t$	Short imperfections: $h \leq 0,1 t$	Not permitted
				> 3	Short imperfections: $h \leq 0,2 t$, but max. 2 mm	Short imperfections: $h \leq 0,1 t$, but max. 1 mm	Short imperfections: $h \leq 0,05 t$, but max. 0,5 mm
1.9	502	Excess weld metal (butt weld)	Smooth transition is required. 	$\geq 0,5$	$h \leq 1 \text{ mm} + 0,25 b$, but max. 10 mm	$h \leq 1 \text{ mm} + 0,15 b$, but max. 7 mm	$h \leq 1 \text{ mm} + 0,1 b$, but max. 5 mm

Table 1 (continued)

No.	Reference to ISO 6520-1:1998	Imperfection designation	Remarks	<i>t</i> mm	Limits for imperfections for quality levels		
					D	C	B
1.10	503	Excessive convexity (fillet weld)		$\geq 0,5$	$h \leq 1 \text{ mm} + 0,25 b$, but max. 5 mm	$h \leq 1 \text{ mm} + 0,15 b$, but max. 4 mm	$h \leq 1 \text{ mm} + 0,1 b$, but max. 3 mm
1.11	504	Excess penetration		0,5 to 3 > 3	$h \leq 1 \text{ mm} + 0,6 b$ $h \leq 1 \text{ mm} + 1,0 b$, but max. 5 mm	$h \leq 1 \text{ mm} + 0,3 b$ $h \leq 1 \text{ mm} + 0,6 b$, but max. 4 mm	$h \leq 1 \text{ mm} + 0,1 b$ $h \leq 1 \text{ mm} + 0,2 b$, but max. 3 mm

Table 1 (continued)

No.	Reference to ISO 6520-1:1998	Imperfection designation	Remarks	t mm	Limits for imperfections for quality levels			
					D	C	B	
1.12	505	Incorrect weld toe	 <p>— butt welds</p>	$\alpha \geq 90^\circ$	$\alpha \geq 100^\circ$	$\alpha \geq 150^\circ$		
			 <p>— fillet welds</p> <p>$\alpha_1 \geq \alpha$ $\alpha_2 \geq \alpha$</p>	$\alpha \geq 90^\circ$	$\alpha \geq 110^\circ$	$\alpha \geq 110^\circ$		
1.13	506	Overlap		$\geq 0,5$	$h \leq 0,2 b$	Not permitted	Not permitted	
1.14	509 511	Sagging Incompletely filled groove	Smooth transition is required	0,5 to 3	Short imperfections: $h \leq 0,25 t$	Short imperfections: $h \leq 0,1 t$	Not permitted	
				> 3	Short imperfections: $h \leq 0,25 t$ but max. 2 mm	Short imperfections: $h \leq 0,1 t$ but max. 1 mm	Short imperfections: $h \leq 0,05 t$ but max. 0,5 mm	
1.15	510	Burn through	—	$\geq 0,5$	Not permitted	Not permitted	Not permitted	

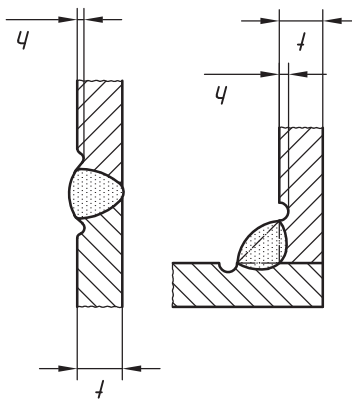
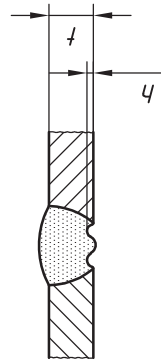
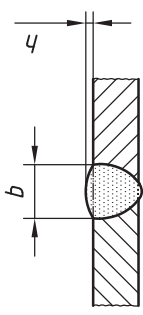
Table 1 (continued)

No.	Reference to ISO 6520-1:1998	Imperfection designation	Remarks	t mm	Limits for imperfections for quality levels		
					D	C	B
1.16	512	Excessive asymmetry of fillet weld (excessive unequal leg length)	In cases where an asymmetric fillet weld has not been prescribed. 	≥ 0,5	$h \leq 2 \text{ mm} + 0,2 a$	$h \leq 2 \text{ mm} + 0,15 a$	$h \leq 1,5 \text{ mm} + 0,15 a$
1.17	515	Root concavity	Smooth transition is required. 	0,5 to 3	$h \leq 0,2 \text{ mm} + 0,1 t$	Short imperfections: $h \leq 0,1 t$	Not permitted
				> 3	Short imperfections: $h \leq 0,2 t$, but max. 2 mm	Short imperfections: $h \leq 0,1 t$, but max. 1 mm	Short imperfections: $h \leq 0,05 t$, but max. 0,5 mm
1.18	516	Root porosity	Spongy formation at the root of a weld due to bubbling of the weld metal at the moment of solidification (e. g. lack of gas backing)	≥ 0,5	Locally permitted	Not permitted	Not permitted

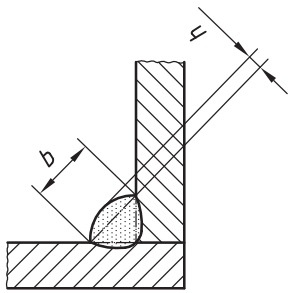
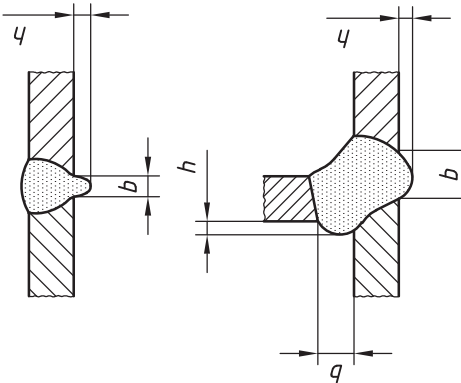
Table 1 (continued)

No.	Reference to ISO 6520-1:1998	Imperfection designation	Remarks	t mm	Limits for imperfections for quality levels		
					D	C	B
1.19	517	Poor restart	—	≥ 0,5	Permitted. The limit depends on the type of imperfection occurred due to restart	Not permitted	Not permitted
1.20	5213	Insufficient throat thickness	Not applicable to processes with proof of greater depth of penetration 	0,5 to 3 > 3	Short imperfections: $h \leq 0,2 \text{ mm} + 0,1 a$ Short imperfections: $h \leq 0,3 \text{ mm} + 0,1 a$, but max. 2 mm	Short imperfections: $h \leq 0,2 \text{ mm}$	Not permitted Not permitted
1.21	5214	Excessive throat thickness	The actual throat thickness of the fillet weld is too large. 	≥ 0,5	Unlimited.	$h \leq 1 \text{ mm} + 0,2 a$, but max. 4 mm	$h \leq 1 \text{ mm} + 0,15 a$, but max. 3 mm
1.22	601	Stray arc	—	≥ 0,5	Permitted, if the properties of the parent metal are not affected.	Not permitted	Not permitted
1.23	602	Spatter	—	≥ 0,5	Acceptance depends on application, e.g. material, corrosion protection		

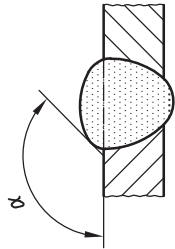
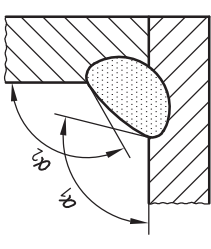
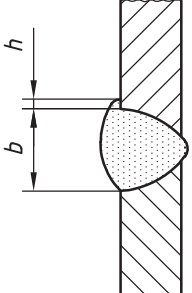
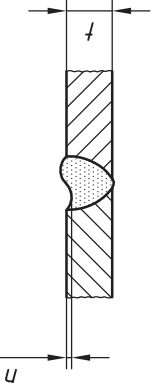
Table 1 (continued)

No.	Reference to ISO 6520-1:1998	Imperfection designation	Remarks	t mm	Limits for imperfections for quality levels		
					D	C	B
2 Internal imperfections							
2.1	100	Cracks	All types of crack except microcracks and crater cracks	≥ 0,5	Not permitted	Not permitted	Not permitted
2.2	1001	Microcracks	A crack usually only visible under the microscope (50 ×)	≥ 0,5	Permitted	Acceptance depends on type of parent metal with particular reference to crack sensitivity	
2.3	2011 2012	Gas pore Uniformly distributed porosity	The following conditions and limits for imperfections shall be fulfilled. See also Annex A for information. a1) Maximum dimension of the area of the imperfections (inclusive of systematic imperfection) related to the projected area NOTE The porosity in the project area depends on the numbers of layers (volume of the weld). a2) Maximum dimension of the cross-sectional area of the imperfections (inclusive of systematic imperfection) related to the fracture area (only applicable to production, welder or procedure tests)	≥ 0,5	for single layer: ≤ 2,5 % for multi-layer: ≤ 5 %	for single layer: ≤ 1,5 % for multi-layer: ≤ 3 %	for single layer: ≤ 1 % for multi-layer: ≤ 2 %
				≥ 0,5	≤ 2,5 %	≤ 1,5 %	≤ 1 %
				≥ 0,5	d ≤ 0,4 s, but max. 5 mm d ≤ 0,4 a, but max. 5 mm	d ≤ 0,3 s, but max. 4 mm d ≤ 0,3 a, but max. 4 mm	d ≤ 0,2 s, but max. 3 mm d ≤ 0,2 a, but max. 3 mm

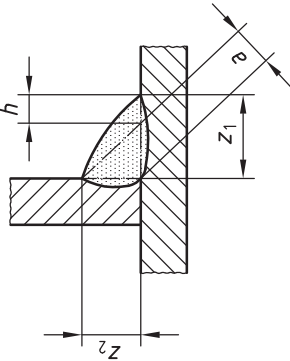
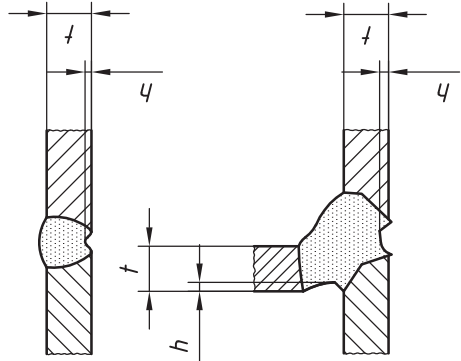
Table 1 (continued)

No.	Reference to ISO 6520-1:1998	Imperfection designation	Remarks	t mm	Limits for imperfections for quality levels		
					D	C	B
2.4	2013	Clustered (localized) porosity	<p>case 1 ($D > d_{A2}$)</p>  <p>case 2 ($D < d_{A2}$)</p>  <p>The sum of the different pore areas ($A_1 + A_2 + \dots$) related to the evaluation area $l_p \times w_p$ (case 1). Reference length for l_p is 100 mm.</p> <p>If D is less than d_{A1} or d_{A2}, whichever is smaller, an envelope surrounding the porosity areas $A_1 + A_2$ shall be considered as one area of imperfection (case 2).</p>				

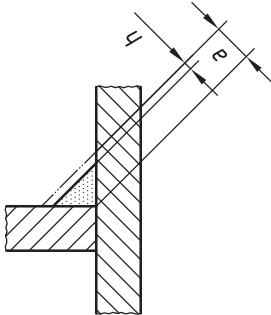
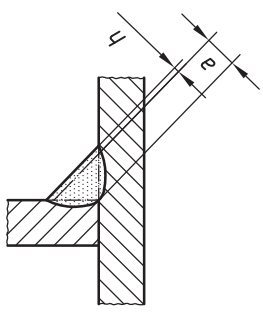
Table 1 (continued)

No.	Reference to ISO 6520-1:1998	Imperfection designation	Remarks	t mm	Limits for imperfections for quality levels		
					D	C	B
2.4	2013	Clustered (localized) porosity	<p>The following dimension conditions and limits for imperfections shall be fulfilled. See also Annex A for information.</p> <p>a) Maximum dimension of the summation of the projected area of the imperfection (inclusive of systematic imperfection)</p> <p>b) Maximum dimension for a single pore for — butt welds — fillet welds</p>	<p>≥ 0,5</p> <p>≤ 16 %</p>	<p>≤ 8 %</p> <p>$d \leq 0,3 s$, but max. 3 mm $d \leq 0,3 a$, but max. 3 mm</p>	<p>≤ 4 %</p> <p>$d \leq 0,2 s$, but max. 2 mm $d \leq 0,2 a$, but max. 2 mm</p>	
2.5	2014	Linear porosity	<p>case 1 ($D > d_2$)</p>  <p>case 2 ($D < d_2$)</p> 				

Table 1 (continued)

No.	Reference to ISO 6520-1:1998	Imperfection designation	Remarks	t mm	Limits for imperfections for quality levels		
					D	C	B
2.5	2014	Linear porosity	<p>The sum of the different pore areas $\left(\frac{d_1^2 \times \pi}{4} + \frac{d_2^2 \times \pi}{4} + \dots \right)$ related to the evaluation area $l_p \times w_p$ (case 1).</p> <p>If D is smaller than the smaller diameter of one of the neighbouring pores, the full connected area of the two pores shall be applied to the sum of imperfections (case 2).</p> <p>The following conditions and limits for imperfections shall be fulfilled. See also Annex A for information.</p> <p>a1) Maximum dimension of the area of the imperfections (inclusive of systematic imperfection) related to the projected area</p> <p>NOTE The porosity in the project area depends on the numbers of layers (volume of the weld).</p> <p>a2) Maximum dimension of the cross-sectional area of the imperfections (inclusive of systematic imperfection) related to the fracture area (only applicable to production, welder or procedure tests)</p> <p>b) Maximum dimension for a single pore for — butt welds — fillet welds</p>	<p>≥ 0,5</p>	<p>for single layer: ≤ 8 % for multi-layer: ≤ 16 %</p>	<p>for single layer: ≤ 4 % for multi-layer: ≤ 8 %</p>	<p>for single layer: ≤ 2 % for multi-layer: ≤ 4 %</p>
				<p>≥ 0,5</p>	<p>≤ 8 %</p>	<p>≤ 4 %</p>	<p>≤ 2 %</p>
				<p>≥ 0,5</p>	<p>$d \leq 0,4 s$, but max. 4 mm $d \leq 0,4 a$, but max. 4 mm</p>	<p>$d \leq 0,3 s$, but max. 3 mm $d \leq 0,3 a$, but max. 3 mm</p>	<p>$d \leq 0,2 s$, but max. 2 mm $d \leq 0,2 a$, but max. 2 mm</p>

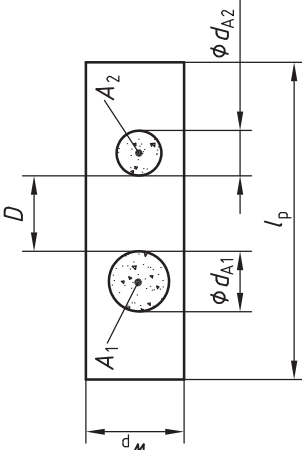
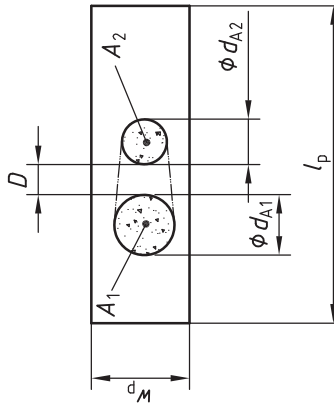
Table 1 (continued)

No.	Reference to ISO 6520-1:1998	Imperfection designation	Remarks	t mm	Limits for imperfections for quality levels		
					D	C	B
2.6	2015 2016	Elongated cavity Wormholes	— butt welds	$\geq 0,5$	$h \leq 0,4 s$, but max. 4 mm $l \leq s$, but max. 75 mm	$h \leq 0,3 s$, but max. 3 mm $l \leq s$, but max. 50 mm	$h \leq 0,2 s$, but max. 2 mm $l \leq s$, but max. 25 mm
			— fillet welds	$\geq 0,5$	$h \leq 0,4 a$, but max. 4 mm $l \leq a$, but max. 75 mm	$h \leq 0,3 a$, but max. 3 mm $l \leq a$, but max. 50 mm	$h \leq 0,2 a$, but max. 2 mm $l \leq a$, but max. 25 mm
2.7	202	Shrinkage cavity	—	$\geq 0,5$	Short imperfections permitted, but not breaking of the surfaces — butt welds: $h \leq 0,4 s$, but max. 4 mm — fillet welds: $h \leq 0,4 a$, but max. 4 mm	Not permitted	Not permitted
2.8	2024	Crater pipe		0,5 to 3 > 3	h or $l \leq 0,2 t$ h or $l \leq 0,2 t$, but max. 2 mm	Not permitted	Not permitted
2.9	300 301 302 303	Solid inclusions Slag inclusions Flux inclusions Oxide inclusions	The larger value of h or l will be measured				
			— butt welds	$\geq 0,5$	$h \leq 0,4 s$, but max. 4 mm $l \leq s$, but max. 75 mm	$h \leq 0,3 s$, but max. 3 mm $l \leq s$, but max. 50 mm	$h \leq 0,2 s$, but max. 2 mm $l \leq s$, but max. 25 mm
			— fillet welds	$\geq 0,5$	$h \leq 0,4 a$, but max. 4 mm $l \leq a$, but max. 75 mm	$h \leq 0,3 a$, but max. 3 mm $l \leq a$, but max. 50 mm	$h \leq 0,2 a$, but max. 2 mm $l \leq a$, but max. 25 mm

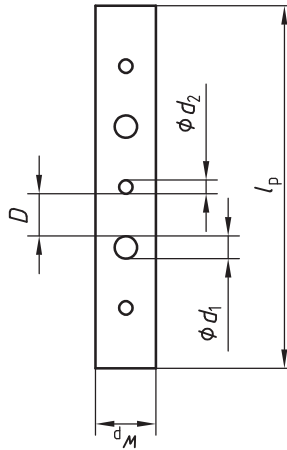
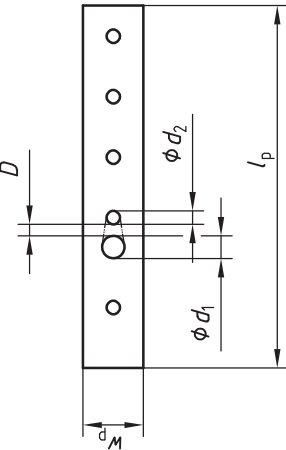
Table 1 (continued)

No.	Reference to ISO 6520-1:1998	Imperfection designation	Remarks	<i>t</i> mm	Limits for imperfections for quality levels		
					D	C	B
2.10	304	Metallic inclusions other than copper	— butt welds — fillet welds	≥ 0,5	$h \leq 0,4 s$, but max. 4 mm	$h \leq 0,3 s$, but max. 3 mm	$h \leq 0,2 s$, but max. 2 mm
2.11	3042	Copper inclusions	—	≥ 0,5	$h \leq 0,4 a$, but max. 4 mm	$h \leq 0,3 a$, but max. 3 mm	$h \leq 0,2 a$, but max. 2 mm
2.12	401	Lack of fusion (incomplete fusion)		≥ 0,5	Not permitted	Not permitted	Not permitted
4011		Lack of side wall fusion			Short imperfections permitted — butt welds: $h \leq 0,4 s$, but max. 4 mm — fillet welds: $h \leq 0,4 a$, but max. 4 mm	Not permitted	Not permitted
4012		Lack of inter-run fusion					
4013		Lack of root fusion					

Table 1 (continued)

No.	Reference to ISO 6520-1:1998	Imperfection designation	Remarks	t mm	Limits for imperfections for quality levels		
					D	C	B
2.13	402	Lack of penetration	 <p>T-joint (fillet weld)</p>	> 0,5	Short imperfection: $h \leq 0,2 a$, but max. 2 mm	Not permitted	Not permitted
			 <p>T-joint (partial penetration)</p>	$\geq 0,5$	Short imperfections: — butt joint: $h \leq 0,2 s$, but max. 2 mm — T-joint: $h \leq 0,2 a$, but max. 2 mm	Short imperfections: — butt joint: $h \leq 0,1 s$, but max. 1,5 mm — fillet joint: $h \leq 0,1 a$, but max. 1,5 mm	Not permitted
			 <p>Butt joint (partial penetration)</p>	$\geq 0,5$	Short imperfection: $h \leq 0,2 t$, but max. 2 mm	Not permitted	Not permitted
			 <p>Butt joint (full penetration)</p>	$\geq 0,5$	Short imperfection: $h \leq 0,2 t$, but max. 2 mm	Not permitted	Not permitted

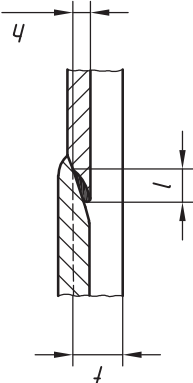
Table 1 (continued)

No.	Reference to ISO 6520-1:1998	Imperfection designation	Remarks	t mm	Limits for imperfections for quality levels		
					D	C	B
3 Imperfections in joint geometry							
3.1	507	Linear misalignment	<p>The limits relate to deviations from the correct position. Unless otherwise specified, the correct position is that when the centrelines coincide (see also Clause 1). t refers to the smaller thickness.</p>  <p>Figure A: Plates and longitudinal welds</p>	0,5 to 3	$h \leq 0,2 \text{ mm} + 0,25 t$	$h \leq 0,2 \text{ mm} + 0,15 t$	$h \leq 0,2 \text{ mm} + 0,1 t$
			 <p>Figure B: Circumferential welds</p>	> 3	$h \leq 0,25 t$, but max. 5 mm	$h \leq 0,15 t$, but max. 4 mm	$h \leq 0,1 t$, but max. 3 mm
				$\geq 0,5$	$h \leq 0,5 t$, but max. 4 mm	$h \leq 0,5 t$, but max. 3 mm	$h \leq 0,5 t$, but max. 2 mm

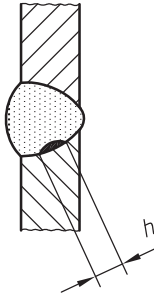
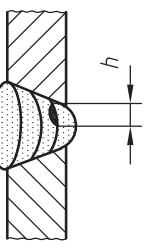
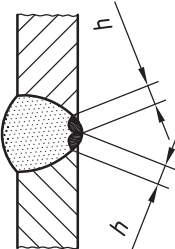
Table 1 (continued)

No.	Reference to ISO 6520-1:1998	Imperfection designation	Remarks	t mm	Limits for imperfections for quality levels		
					D	C	B
3.2	617	Incorrect root gap for fillet welds	<p>Gap between the parts to be joined. Gaps exceeding the appropriate limit may, in certain cases, be compensated for by a corresponding increase in the throat.</p> 	0,5 to 3 > 3	$h \leq 0,5 \text{ mm} + 0,1 a$ $h \leq 1 \text{ mm} + 0,3 a$, but max. 4 mm	$h \leq 0,3 \text{ mm} + 0,1 a$ $h \leq 0,5 \text{ mm} + 0,2 a$, but max. 3 mm	$h \leq 0,2 \text{ mm} + 0,1 a$ $h \leq 0,5 \text{ mm} + 0,1 a$, but max. 2 mm
4 Multiple imperfections							
4.1	None	Multiple imperfections in any cross section	 <p>$h_1 + h_2 + h_3 + h_4 + h_5 = \Sigma h$</p>	0,5 to 3 > 3	Not permitted Maximum total height of imperfections $\Sigma h \leq 0,4 t$ or $\leq 0,25 a$	Not permitted Maximum total height of imperfections $\Sigma h \leq 0,3 t$ or $\leq 0,2 a$	Not permitted Maximum total height of imperfections $\Sigma h \leq 0,2 t$ or $\leq 0,15 a$

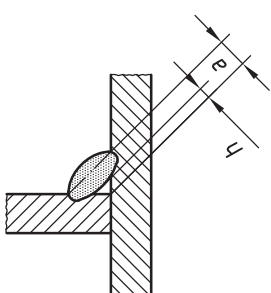
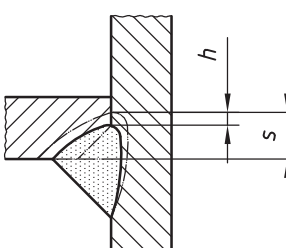
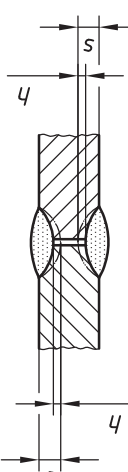
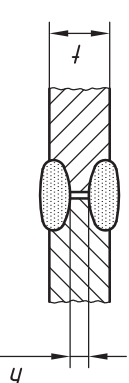
Table 1 (continued)

No.	Reference to ISO 6520-1:1998	Imperfection designation	Remarks	t mm	Limits for imperfections for quality levels		
					D	C	B
4.1			 <p>$h_1 + h_2 + h_3 + h_4 + h_5 = \Sigma h$</p>				
4.2	None	Projected or cross-sectional area in longitudinal direction	 <p>case 1 ($D > l_3$)</p> <p>$h_1 \times l_1 + h_2 \times l_2 + h_3 \times l_3 = \Sigma h \times l$</p>				

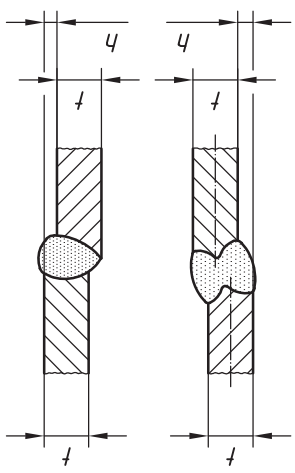
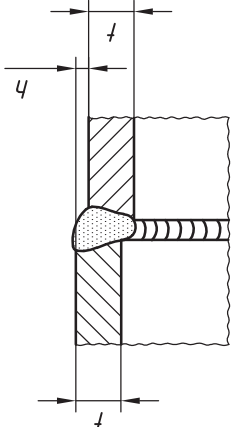
Table 1 (continued)

No.	Reference to ISO 6520-1:1998	Imperfection designation	Remarks	<i>t</i> mm	Limits for imperfections for quality levels		
					D	C	B
4.2			<p>case 2 ($D < l_3$)</p>  <p> $h_1 \times l_1 + h_2 \times l_2 + \left(\frac{h_2 + h_3}{2} \right) \times D + h_3 \times l_3 = \Sigma h \times l$ </p> <p>The sum of the areas $\Sigma h \times l$ shall be calculated as a percentage to the evaluation area $l_p \times w_p$ (case 1).</p> <p>If D is smaller than the shorter length of one of the neighbouring imperfections, the full connection of the two imperfections shall be applied to the sum of imperfections (case 2).</p> <p>NOTE See also Annex A for information.</p>	$\geq 0,5$	$\Sigma h \times l \leq 16 \%$	$\Sigma h \times l \leq 8 \%$	$\Sigma h \times l \leq 4 \%$

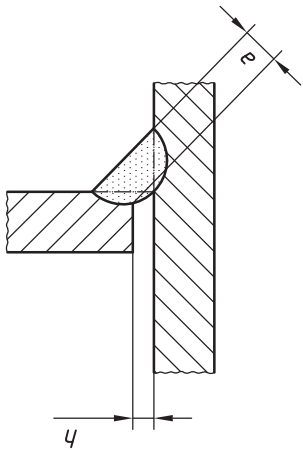
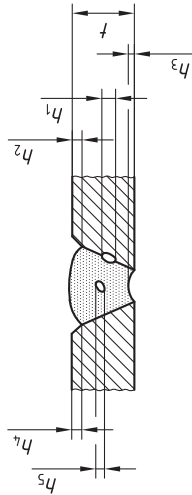
Annex A (informative)

Examples of determination of percentage (%) porosity

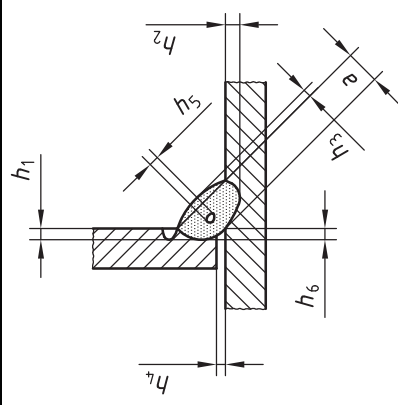
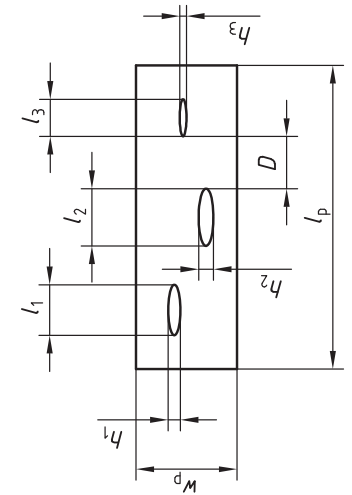
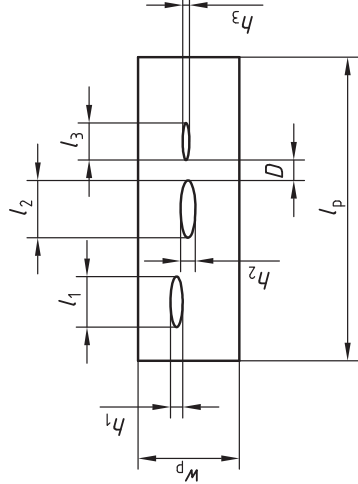
Figures A.1 to A.9 give a presentation of different percentage porosities. This should assist the assessment of porosity on projected areas (radiographs) or cross-sectional areas.

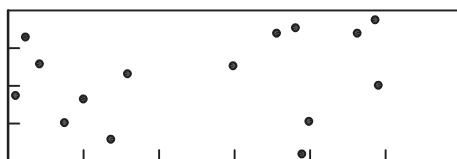

Figure A.1 — 1 surface percent, 15 pores, $d = 1$ mm

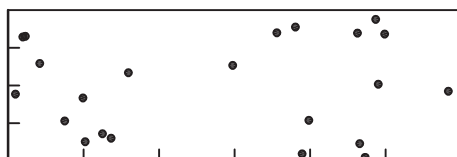

Figure A.2 — 1,5 surface percent, 23 pores, $d = 1$ mm

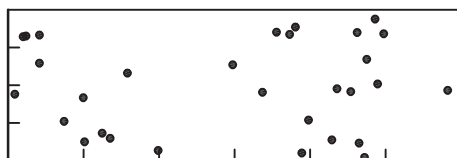

Figure A.3 — 2 surface percent, 30 pores, $d = 1$ mm

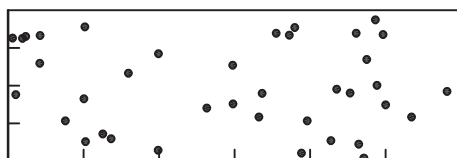

Figure A.4 — 2,5 surface percent, 38 pores, $d = 1$ mm

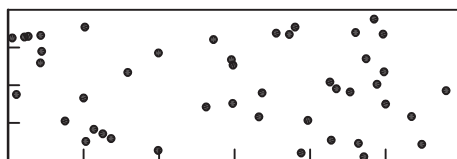

Figure A.5 — 3 surface percent, 45 pores, $d = 1$ mm

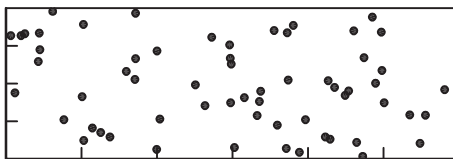

Figure A.6 — 4 surface percent, 61 pores, $d = 1$ mm

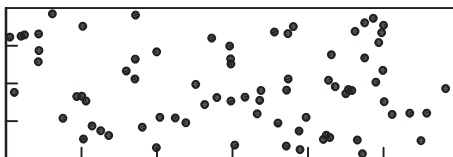

Figure A.7 — 5 surface percent, 76 pores, $d = 1$ mm

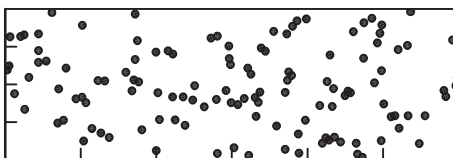

Figure A.8 — 8 surface percent, 122 pores, $d = 1$ mm

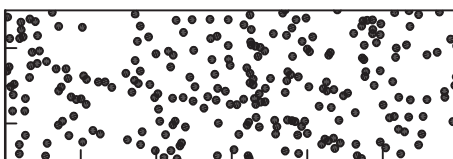

Figure A.9 — 16 surface percent, 244 pores, $d = 1$ mm

Annex B (informative)

Additional information and guidelines for use of this International Standard

This International Standard specifies requirements for three quality levels for imperfections in welded joints of steel, nickel, titanium and their alloys for fusion welding processes (beam welding excluded) for weld thickness $\geq 0,5$ mm. It may be used, where applicable, for other fusion welding processes or weld thicknesses.

Different components are very often produced for different applications, but to similar requirements. The same requirements should, however, apply to identical components produced in different workshops to ensure that work is carried out using the same criteria. The consistent application of this international Standard is one of the fundamental cornerstones of a quality management system for use in the production of welded structures.

The summary of multiple imperfections shows a theoretical possibility of superimposed individual imperfections. In such a case, the total summation of all permitted deviations shall be restricted by the stipulated values for the different imperfections, i.e., the limit value of a single imperfection $\leq h$, e.g., for a single pore, shall not be exceeded.

This International Standard may be used in conjunction with a catalogue of realistic illustrations showing the size of the permissible imperfections for the various quality levels, by means of photographs showing the face and root side and/or reproductions of radiographs and of photomicrographs showing the cross-section of the weld. An example of such a catalogue is given with "Reference radiographs for the assessment of weld imperfections in accordance with ISO 5817", published by International Institute of Welding (IIW) and Deutscher Verlag für Schweißen und verwandte Verfahren, Düsseldorf. This catalogue may be used with reference cards to assess the various imperfections and may also be used when opinions differ as to the permissible size of imperfections.

Bibliography

- [1] ISO 17635, *Non-destructive examination of welds — General rules for fusion welds in metallic materials*

BSI — British Standards Institution

BSI is the independent national body responsible for preparing British Standards. It presents the UK view on standards in Europe and at the international level. It is incorporated by Royal Charter.

Revisions

British Standards are updated by amendment or revision. Users of British Standards should make sure that they possess the latest amendments or editions.

It is the constant aim of BSI to improve the quality of our products and services. We would be grateful if anyone finding an inaccuracy or ambiguity while using this British Standard would inform the Secretary of the technical committee responsible, the identity of which can be found on the inside front cover.
Tel: +44 (0)20 8996 9000. Fax: +44 (0)20 8996 7400.

BSI offers members an individual updating service called PLUS which ensures that subscribers automatically receive the latest editions of standards.

Buying standards

Orders for all BSI, international and foreign standards publications should be addressed to Customer Services. Tel: +44 (0)20 8996 9001.
Fax: +44 (0)20 8996 7001. Email: orders@bsi-global.com. Standards are also available from the BSI website at <http://www.bsi-global.com>.

In response to orders for international standards, it is BSI policy to supply the BSI implementation of those that have been published as British Standards, unless otherwise requested.

Information on standards

BSI provides a wide range of information on national, European and international standards through its Library and its Technical Help to Exporters Service. Various BSI electronic information services are also available which give details on all its products and services. Contact the Information Centre.
Tel: +44 (0)20 8996 7111. Fax: +44 (0)20 8996 7048. Email: info@bsi-global.com.

Subscribing members of BSI are kept up to date with standards developments and receive substantial discounts on the purchase price of standards. For details of these and other benefits contact Membership Administration.
Tel: +44 (0)20 8996 7002. Fax: +44 (0)20 8996 7001.
Email: membership@bsi-global.com.

Information regarding online access to British Standards via British Standards Online can be found at <http://www.bsi-global.com/bsonline>.

Further information about BSI is available on the BSI website at <http://www.bsi-global.com>.

Copyright

Copyright subsists in all BSI publications. BSI also holds the copyright, in the UK, of the publications of the international standardization bodies. Except as permitted under the Copyright, Designs and Patents Act 1988 no extract may be reproduced, stored in a retrieval system or transmitted in any form or by any means – electronic, photocopying, recording or otherwise – without prior written permission from BSI.

This does not preclude the free use, in the course of implementing the standard, of necessary details such as symbols, and size, type or grade designations. If these details are to be used for any other purpose than implementation then the prior written permission of BSI must be obtained.

Details and advice can be obtained from the Copyright & Licensing Manager.
Tel: +44 (0)20 8996 7070. Fax: +44 (0)20 8996 7553.
Email: copyright@bsi-global.com.